

HOW DO I MEASURE AN EXISTING BUILDING?

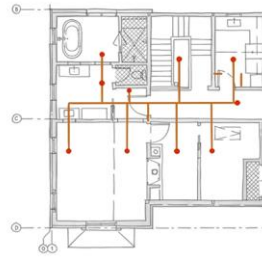

M



M

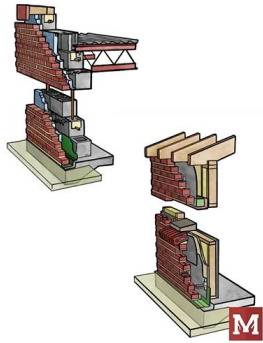
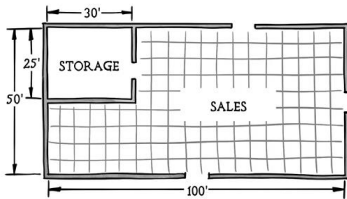
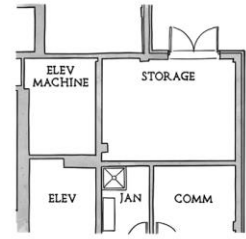

M

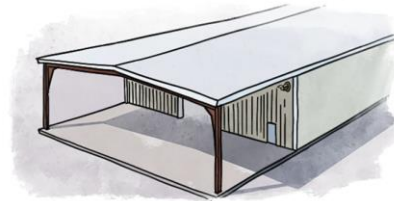

M

NOTES

A large area of dotted lines for taking notes.

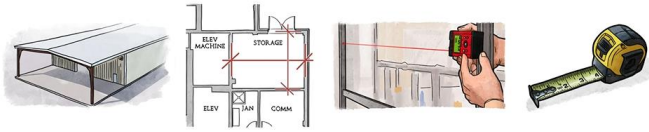

M

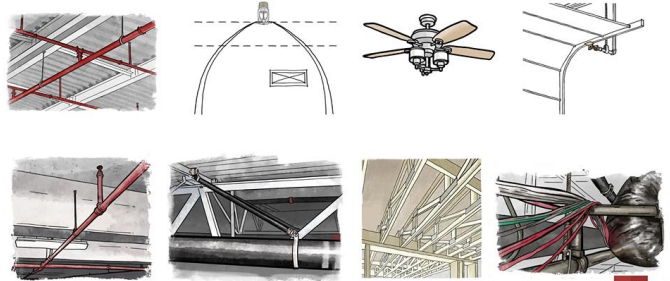

M

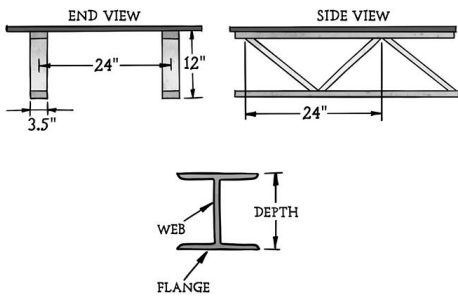

M



M

NOTES

A large area of dotted lines for taking notes.